

SEL SynchroWAVE Archive Presentation

NASPI Data and Archive Workshop
4/15/2019

Jared Bestebreur, Lead Product Manager
Schweitzer Engineering Laboratories

Time-Series Network Architecture

Traditional Synchrophasor Architecture

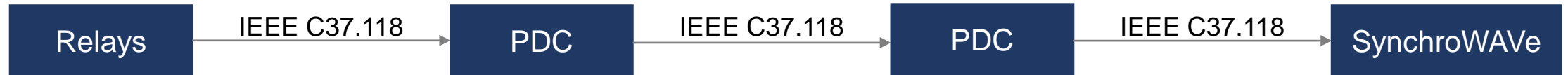

Time-Series Network Architecture

Time-Series Architecture

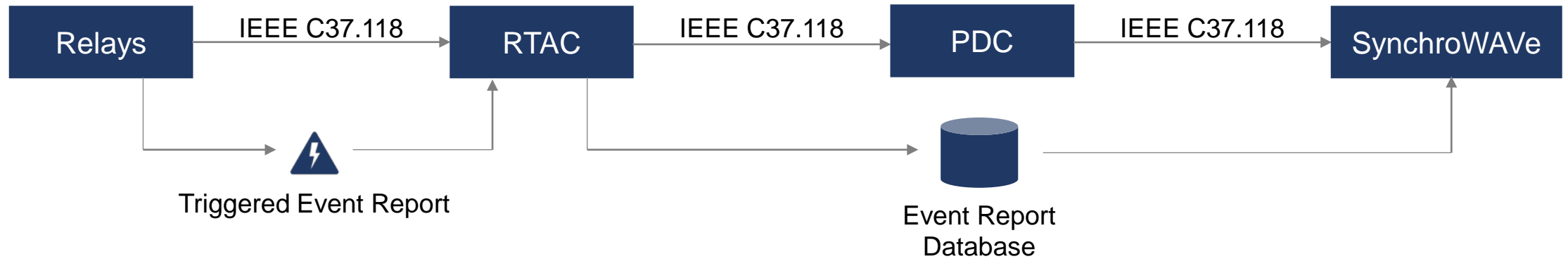

Time-Series Network Architecture

Time-Series Architecture

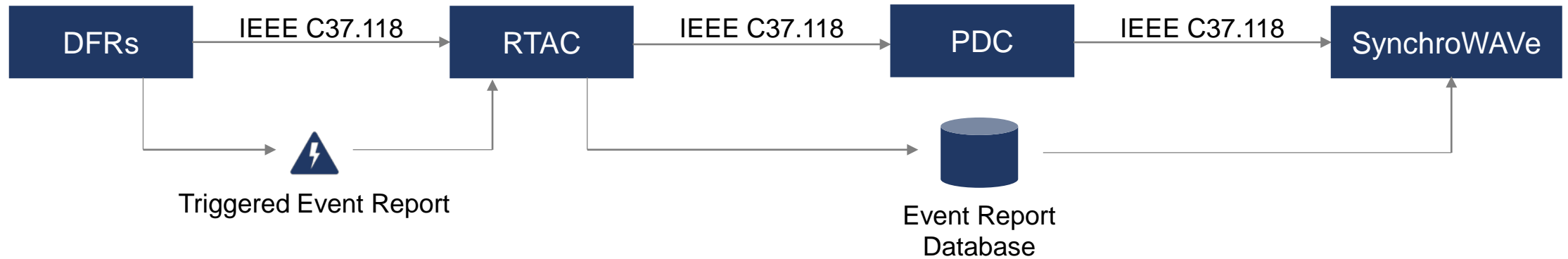

Time-Series Network Architecture

Time-Series Architecture with Local Control

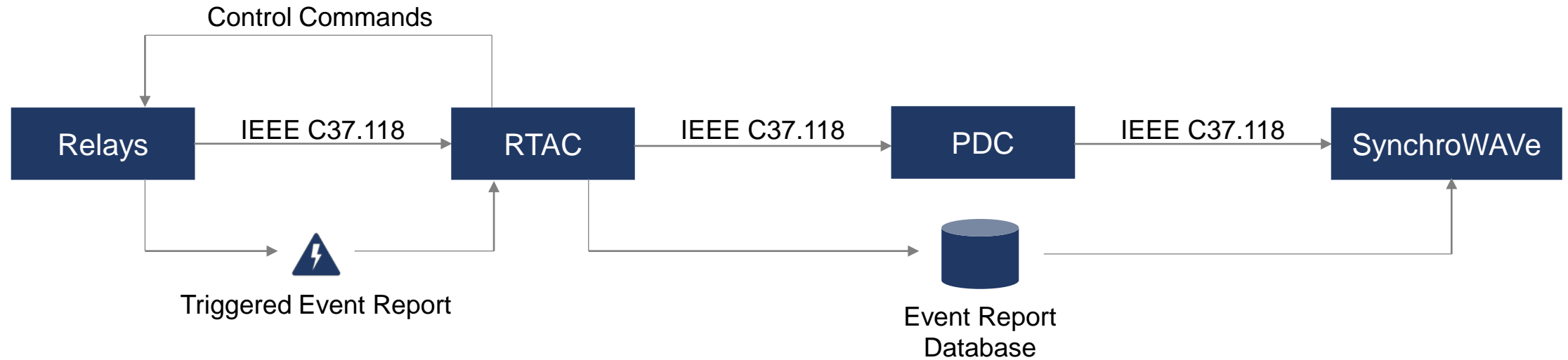

Time-Series Network Architecture

Time-Series Architecture

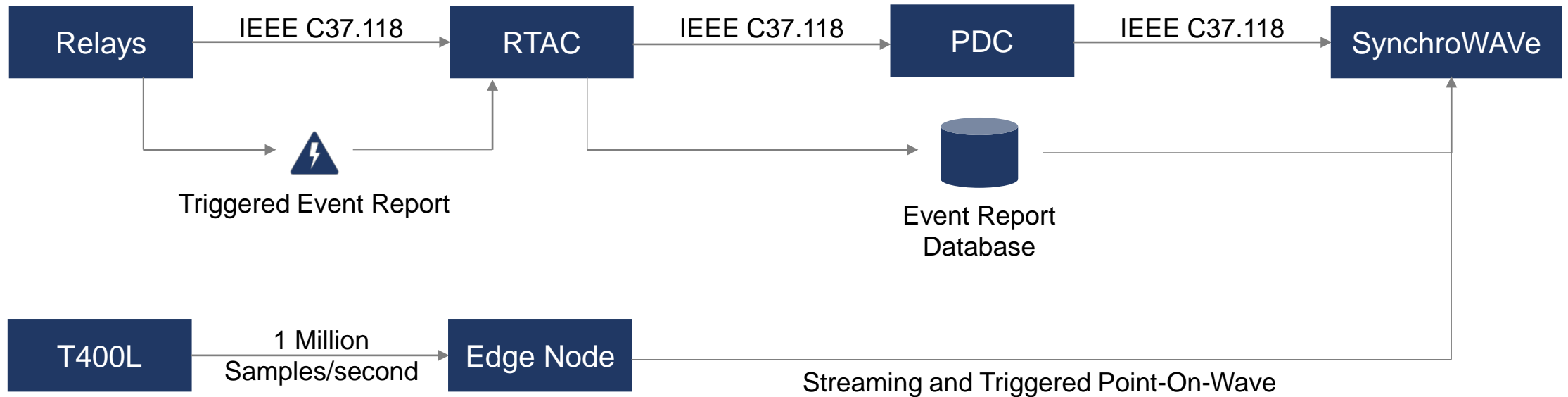

SynchroWAVE Central Architecture

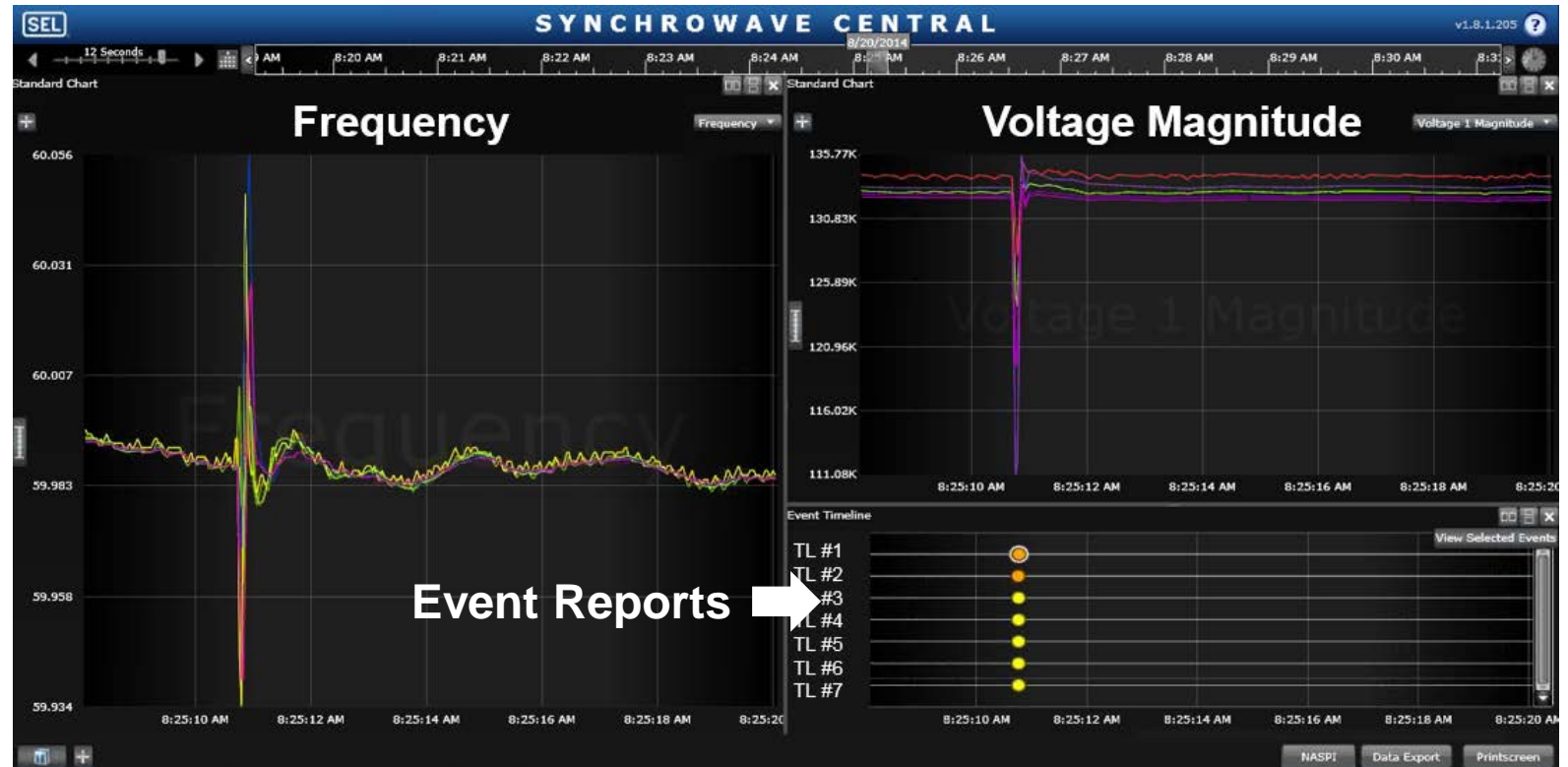
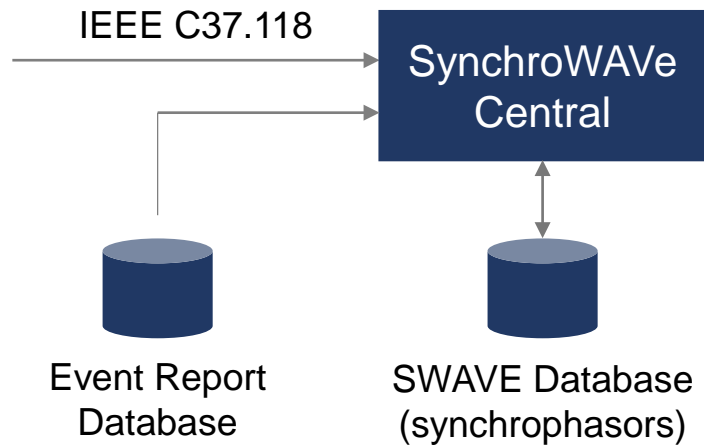

Event Reports



SynchroWAVE SWAVE Database

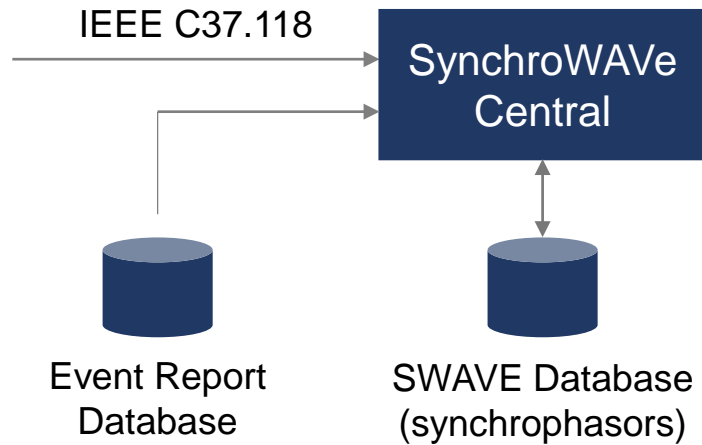

SWAVE Database Features:

- Time-series database.
- File/Folder architecture (Local, SAN, NAS)
- Simple management.
- 1 file per day, per PMU.
- Raw file viewer.
- Max/Min Index for fast 1 second to 1 year zoom.

SynchroWAVE SWAVE Database Example

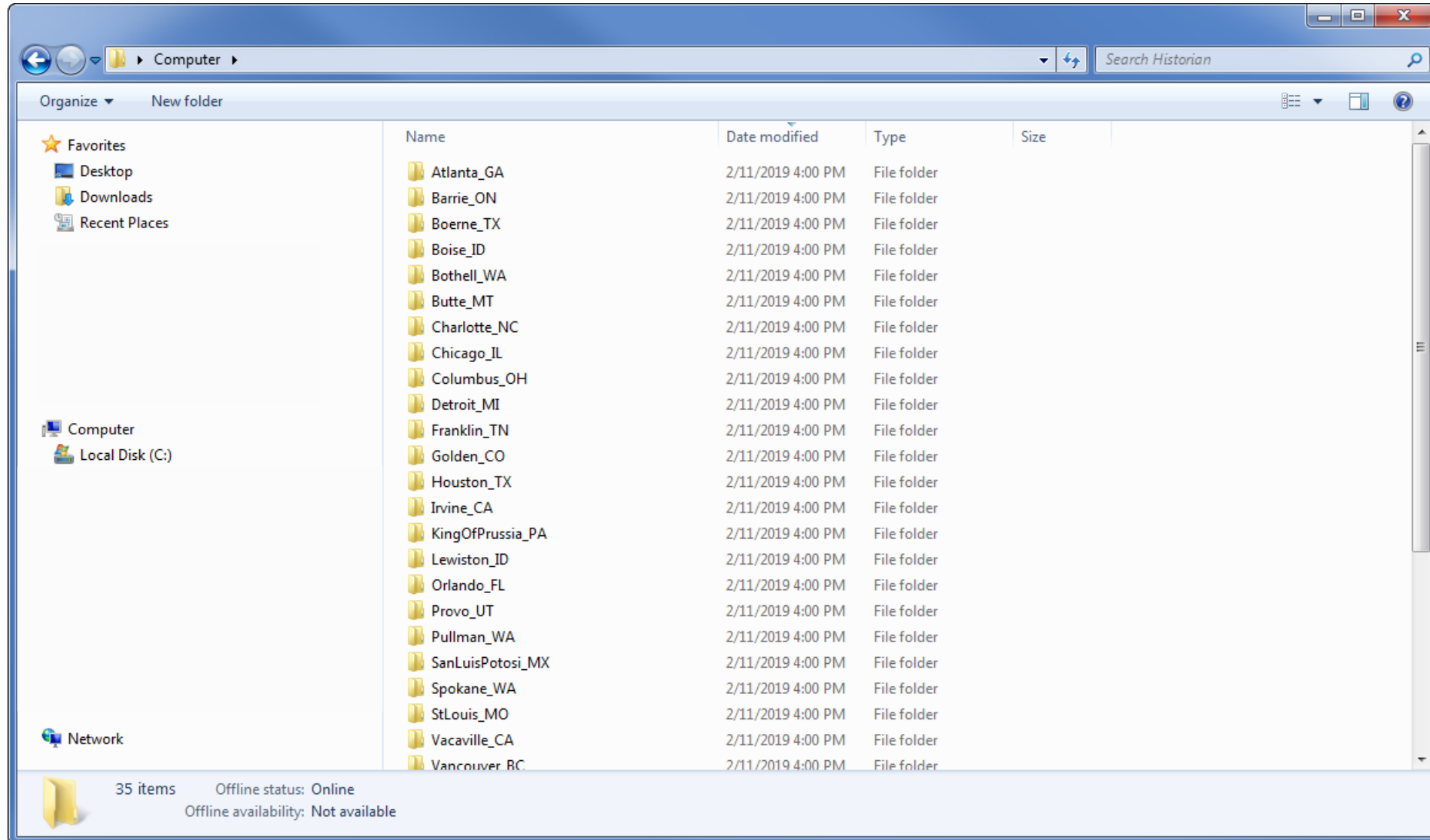

SynchroWAVE SWAVE Database Example

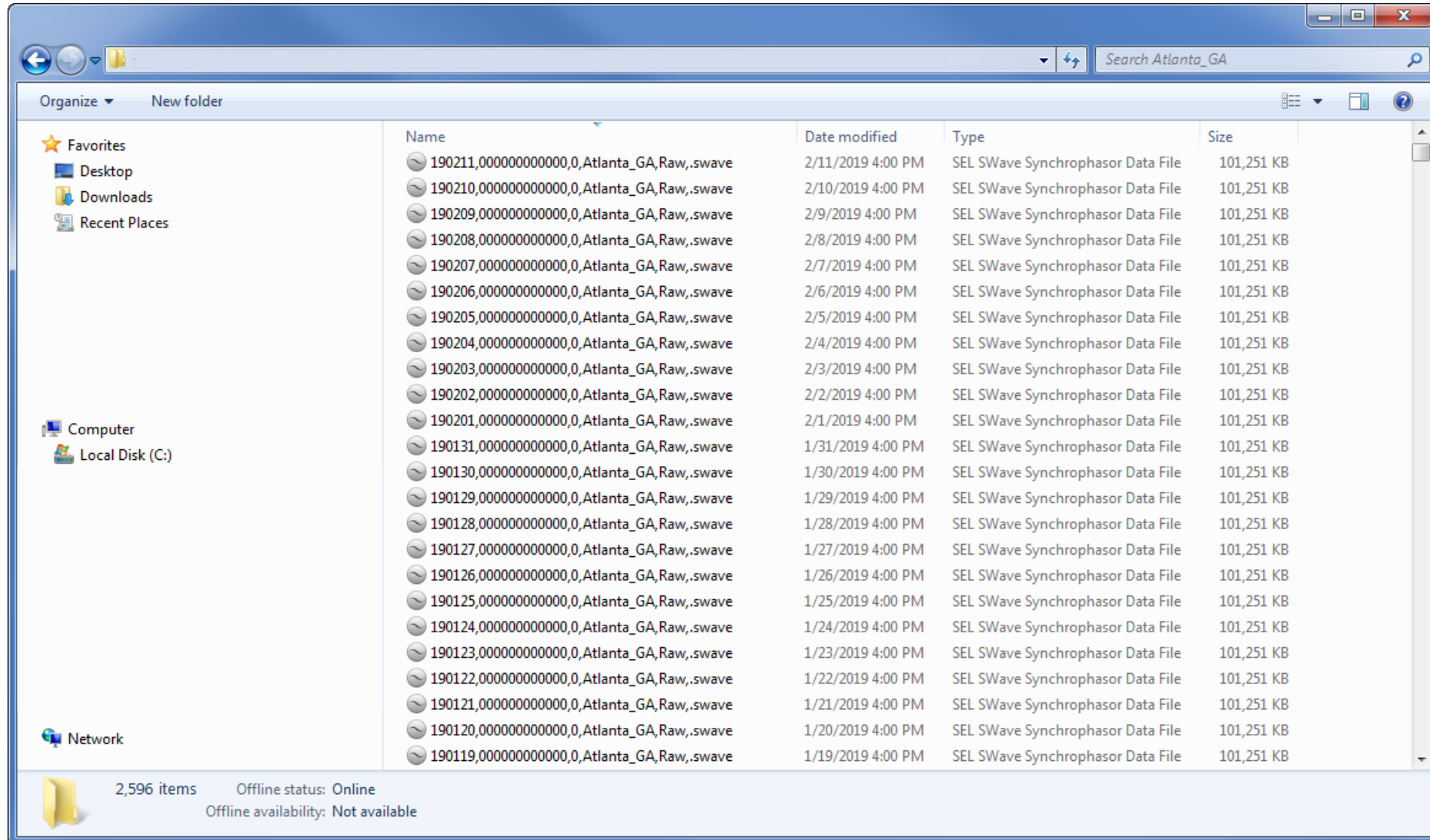

SynchroWAVE SWAVE Database Example

The screenshot shows the SynchroWAVE Viewer application window. The title bar reads: "K:\R&D Labs\synchrophasors_com\Archived Data\Historian\Atlanta_GA\190211,000000000000,0,Atlanta_GA,Raw,.swave - SynchroWAVE Viewer". The application interface includes a menu bar with "File", a status bar with "Station Name: AtlantaGA Station ID: 303 Message Rate: 60 MsgPerSec Nominal Frequency: 60 [] 'The Matrix' Mode Time Search:", and a main data table.

Timestamp	Status	V1PM:M(V)	V1PM:Ang	Frequency	DFrequency
2019-02-11 00:00:00.000	Good	121.220504760742	163.405639648438	60.0039291381836	-0.00789999961853027
2019-02-11 00:00:00.016	Good	121.21028137207	163.432662963867	60.0045051574707	-0.00824000034481287
2019-02-11 00:00:00.033	Good	121.199295043945	163.461929321289	60.0048789978027	-0.0113000003620982
2019-02-11 00:00:00.050	Good	121.190139770508	163.487167358398	60.0042037963867	-0.0171600002795458
2019-02-11 00:00:00.066	Good	121.187004089355	163.511932373047	60.0041275024414	-0.0172700006514788
2019-02-11 00:00:00.083	Good	121.186859130859	163.540161132813	60.0047073364258	-0.00980000011622906
2019-02-11 00:00:00.100	Good	121.181129455566	163.571395874023	60.0052032470703	-0.000820000015664846
2019-02-11 00:00:00.116	Good	121.173263549805	163.60383605957	60.0054054260254	0.00312000000849366
2019-02-11 00:00:00.133	Good	121.168128967285	163.634429931641	60.0051002502441	-0.000330000009853393
2019-02-11 00:00:00.150	Good	121.16234588623	163.66389465332	60.0049095153809	0.000569999974686652
2019-02-11 00:00:00.166	Good	121.15943145752	163.692337036133	60.0047416687012	0.00487999990582466
2019-02-11 00:00:00.183	Good	121.163932800293	163.720230102539	60.0046463012695	0.000850000011269003
2019-02-11 00:00:00.200	Good	121.16975402832	163.748931884766	60.0047836303711	-0.000560000014957041
2019-02-11 00:00:00.216	Good	121.172698974609	163.780075073242	60.0051918029785	0.00592999998480082
2019-02-11 00:00:00.233	Good	121.172546386719	163.814910888672	60.0058059692383	0.0100600002333522
2019-02-11 00:00:00.250	Good	121.169548034668	163.849670410156	60.0057907104492	0.00651000021025538
2019-02-11 00:00:00.266	Good	121.168113708496	163.878021240234	60.0047264099121	-0.00286999996751547
2019-02-11 00:00:00.283	Good	121.17658996582	163.902526855469	60.0040855407715	-0.00795000046491623
2019-02-11 00:00:00.300	Good	121.187194824219	163.929489135742	60.0044937133789	-0.0036599999293685
2019-02-11 00:00:00.316	Good	121.185256958008	163.957717895508	60.0047035217285	-0.00124000001233071
2019-02-11 00:00:00.333	Good	121.181076049805	163.983642578125	60.004322052002	-0.00252000009641051
2019-02-11 00:00:00.350	Good	121.183883666992	164.009887695313	60.0043716430664	-0.0016499999910593
2019-02-11 00:00:00.366	Good	121.18180847168	164.036361694336	60.0044097900391	-0.00224000005982816
2019-02-11 00:00:00.383	Good	121.170539855957	164.059280395508	60.0038223266602	-0.00822999980300665
2019-02-11 00:00:00.400	Good	121.164604187012	164.079452514648	60.003360748291	-0.0146700004115701
2019-02-11 00:00:00.416	Good	121.168128967285	164.101776123047	60.0037231445313	-0.0124099999666214
2019-02-11 00:00:00.433	Good	121.171180725098	164.129547119141	60.0046234130859	-0.000609999988228083
2019-02-11 00:00:00.450	Good	121.169136047363	164.155853271484	60.0043869018555	0.00181000004522502
2019-02-11 00:00:00.466	Good	121.166473388672	164.174057006836	60.0030364990234	-0.00874000042676926
2019-02-11 00:00:00.483	Good	121.167854309082	164.192855834961	60.0031318664551	-0.00942999962717295



Synchrowave Platform

Power System Operations and Analytics

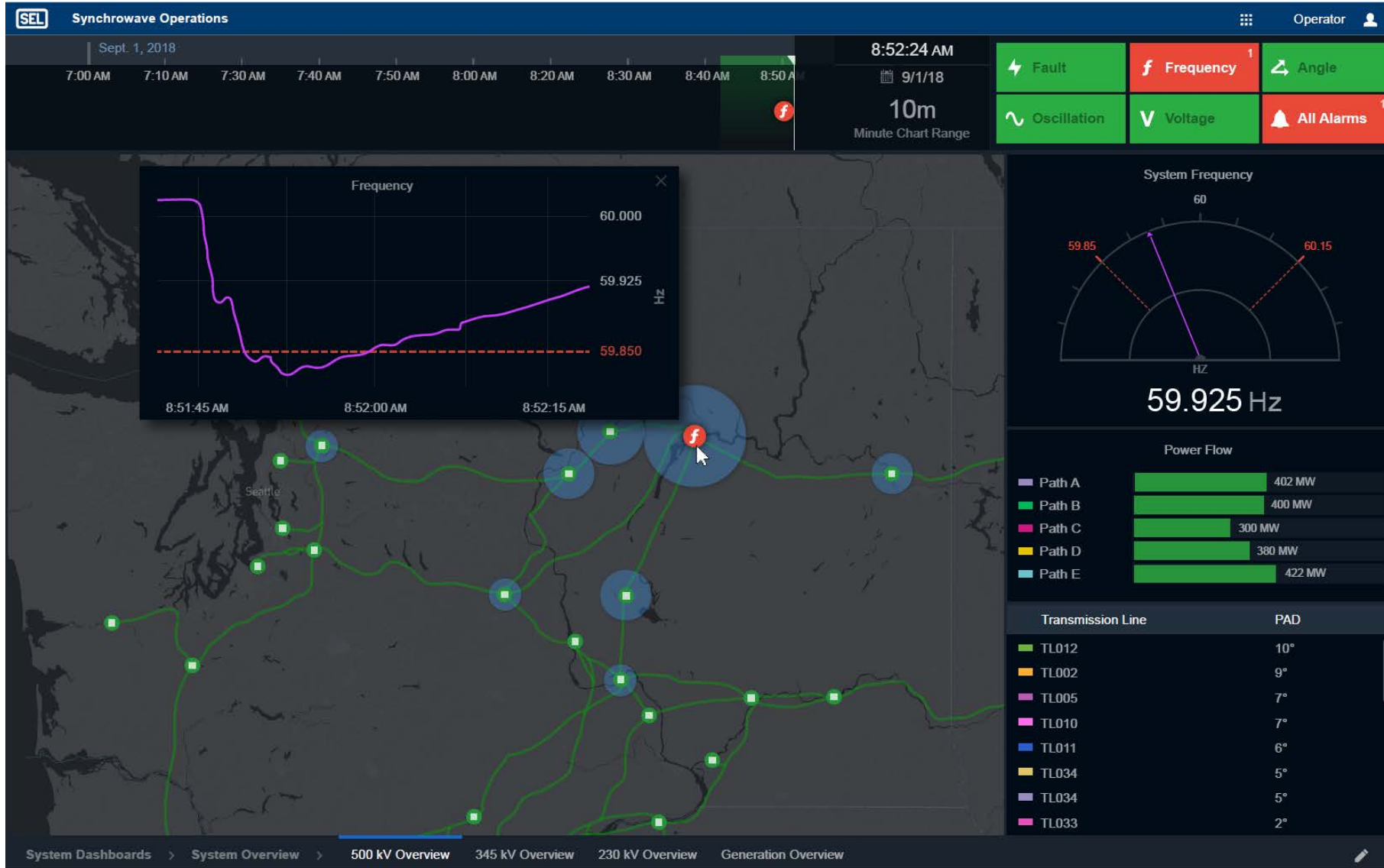

Open Application Platform

Develop, Integrate, Customize.

Integration Applications



Interface

SEL Applications



Interface

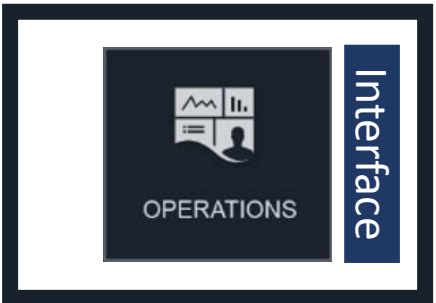

Interface

SEL and Custom Applications

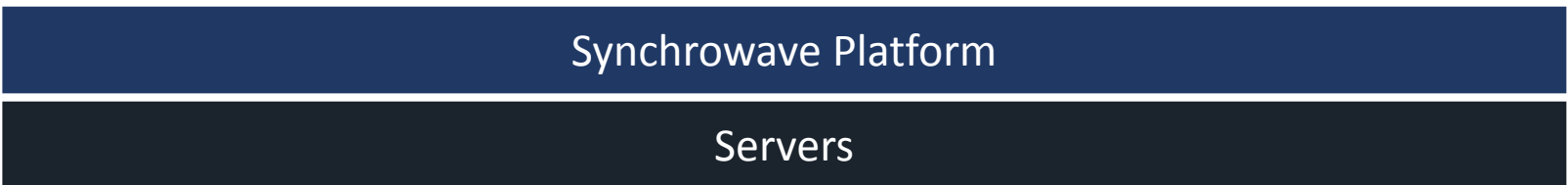

Integrate Multiple Database Applications

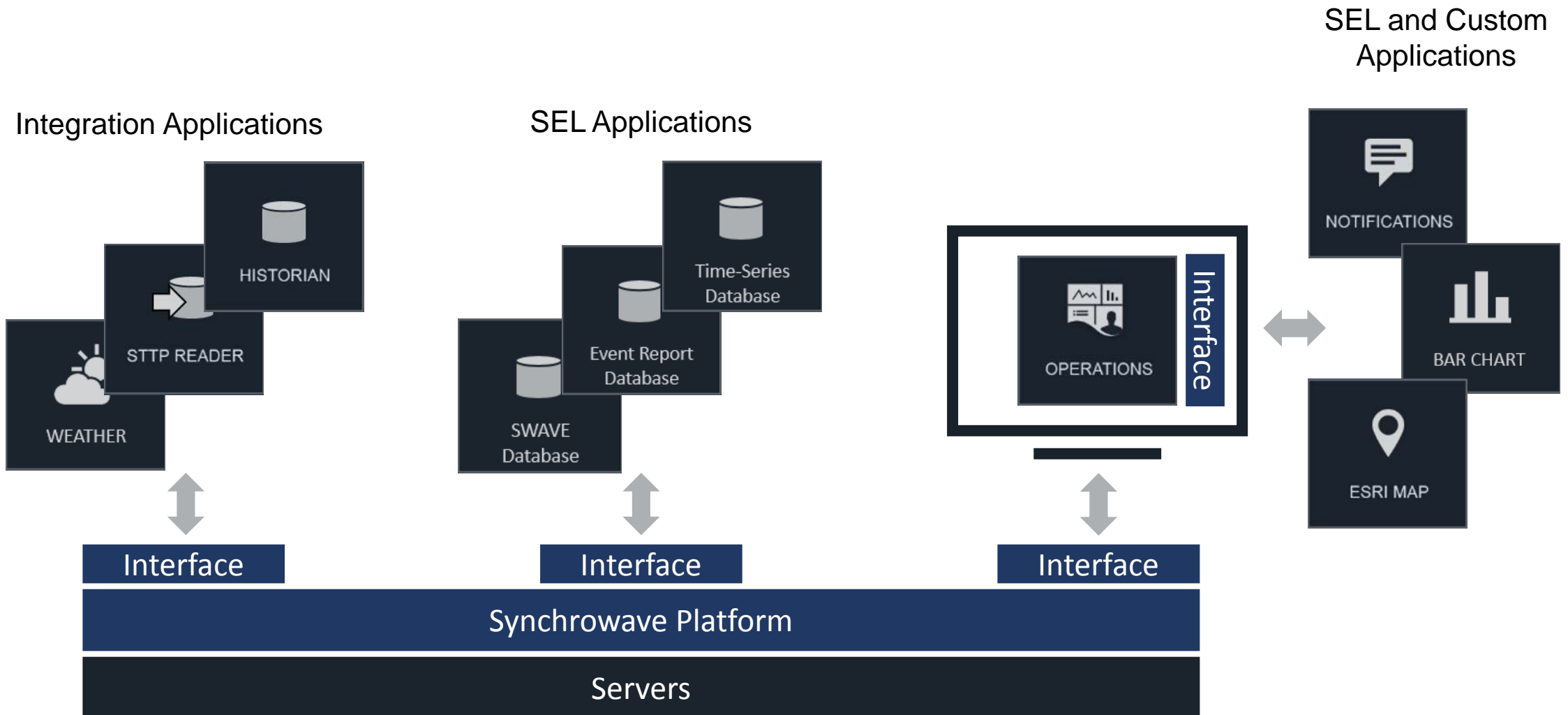

Thank You!